

DIGITAL CONTROLLER WITH DEFROST AND FANS MANAGEMENT XR06CX

1. CONTENTS

1. Contents	1
2. General warnings	1
3. General description	1
4. Regulation	1
5. Defrost	1
6. Fans	1
7. Front panel commands	1
8. Parameters	2
9. Digital inputs (ONLY XR03CX)	2
10. Installation and mounting	2
11. Electrical connections	2
12. How to use the hot key	2
13. Alarm signalling	2
14. Technical data	2
15. Connections	3
16. Default setting values	3

2. GENERAL WARNINGS

PLEASE READ BEFORE USING THIS MANUAL

- This manual is part of the product and should be kept near the instrument for easy and quick reference.
- The instrument shall not be used for purposes different from those described hereunder. It cannot be used as a safety device.
- Check the application limits before proceeding.

SAFETY PRECAUTIONS

- Check the supply voltage is correct before connecting the instrument.
- Do not expose to water or moisture: use the controller only within the operating limits avoiding sudden temperature changes with high atmospheric humidity to prevent formation of condensation
- Warning: disconnect all electrical connections before any kind of maintenance.
- Fit the probe where it is not accessible by the End User. The instrument must not be opened.
- In case of failure or faulty operation send the instrument back to the distributor or to "Dixell S.p.A." (see address) with a detailed description of the fault.
- Consider the maximum current which can be applied to each relay (see Technical Data).
- Ensure that the wires for probes, loads and the power supply are separated and far enough from each other, without crossing or intertwining.
- In case of applications in industrial environments, the use of mains filters (our mod. FT1) in parallel with inductive loads could be useful.

3. GENERAL DESCRIPTION

The **XR06CX**, format **32 x 74 x 60 mm**, is microprocessor based controller, suitable for applications on medium or low temperature ventilated refrigerating units. It has three relay outputs to control compressor, fan, and defrost which can be either electrical or reverse cycle (hot gas). The device is also provided with 2 NTC probe inputs, the first one for temperature control and the second one to be located onto the evaporator, to control the defrost termination temperature and to managed the fan and it's provided with a configurable digital input. With the **HOTKEY** it's possible to program the instrument in a quick and easy way.

4. REGULATION

The regulation is performed according to the temperature measured by the thermostat probe with a positive differential from the set point: if the temperature increases and reaches set point plus differential the compressor is started and then turned off when the temperature reaches the set point value again.

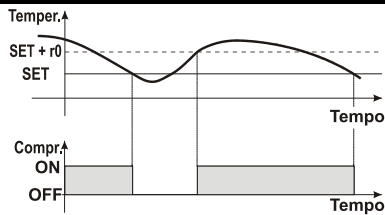

In case of fault in the thermostat probe the start and stop of the compressor are timed through parameters "Cy" and "Cn".

5. DEFROST

Two defrost modes are available through the "td" parameter:

- td=EL** → defrost through electrical heater (compressor OFF)
- td=in** → hot gas defrost (compressor ON).

Other parameters are used to control the interval between defrost cycles (**id**), its maximum length (**Md**) and two defrost modes: timed or controlled by the evaporator's probe. At the end of defrost dripping time is started, its length is set in the **dt** parameter. With **dt=0** the dripping time is disabled.

6. FANS

With **FC** parameter it can be selected the fans functioning:

- FC=cn** → will switch ON and OFF with the compressor and **not run** during defrost
- FC=on** → fans will run even if the compressor is off, and not run during defrost

After defrost, there is a timed fan delay allowing for drip time, set by means of the "Fd" parameter.

- FC=cy** → fans will switch ON and OFF with the compressor and **run** during defrost
- FC=oY** → fans will run continuously also during defrost.

An additional parameter "FS" provides the setting of temperature, detected by the evaporator probe, above which the fans are always OFF. This is used to make sure circulation of air only if his temperature is lower than set in "FS"

FANS AND DIGITAL INPUT

When the digital input is configured as door switch **iF=do**, fans and compressor status depends on the **dC** parameter value:

- dC=no** → normal regulation;
- dC=Fn** → fans OFF;
- dC=cP** → compressor OFF;
- dC=Fc** → compressor and fans OFF.

When **rd=y**, the regulation restart with door open alarm.

7. FRONT PANEL COMMANDS



SET

To display target set point, in programming mode it selects a parameter or confirm an operation



 To start a manual defrost



 In programming mode it browses the parameter codes or increases the displayed value

 In programming mode it browses the parameter codes or decreases the displayed value

AUX

KEYS COMBINATION



-  To lock or unlock the keyboard
- SET** +  To enter in programming mode
- SET** +  To return to room temperature display

LED	MODE	SIGNIFICATO
	On	Compressor enabled
	Flashing	Anti short cycle delay enabled (AC parameter)
	On	Defrost in progress
	Flashing	Dripping in progress
	On	Fans output enabled
	Flashing	Fans delay after defrost
°C	On	Measurement unit
	Flashing	Programming mode
°F	On	Measurement unit
	Flashing	Programming mode

HOW TO SEE THE SET POINT

- Push and immediately release the **SET** key, the set point will be showed;
- Push and immediately release the **SET** key or wait about 5s to return to normal visualisation.

HOW TO CHANGE THE SETPOINT



- Push the **SET** key for more than 2 seconds to change the Set point value;
- The value of the set point will be displayed and the "°C" or "°F" LED starts blinking;
- To change the Set value push the  or  arrows.
- To memorise the new set point value push the **SET** key again or wait 10s.

HOW TO START A MANUAL DEFROST

Push the **DEF**  key for more than 2 seconds and a manual defrost will start

HOW TO CHANGE A PARAMETER VALUE

To change the parameter's value operate as follows:

- Enter the Programming mode by pressing the **SET**+  keys for 3s ("°C" or "°F" LED starts blinking).
- Select the required parameter. Press the "**SET**" key to display its value
- Use  or  to change its value.
- Press "**SET**" to store the new value and move to the following parameter.



To exit: Press **SET**+  or wait 15s without pressing a key.

NOTE: the set value is stored even when the procedure is exited by waiting the time-out to expire.



HIDDEN MENU

The hidden menu includes all the parameters of the instrument.

HOW TO ENTER THE HIDDEN MENU

- Enter the Programming mode by pressing the **SET**+  keys for 3s ("°C" or "°F" LED starts blinking).
- Released the keys, then push again the **SET**+  keys for more than 7s. The L2 label will be displayed immediately followed from the Hy parameter.

NOW YOU ARE IN THE HIDDEN MENU.

- Select the required parameter.
- Press the "**SET**" key to display its value
- Use  or  to change its value.
- Press "**SET**" to store the new value and move to the following parameter.

To exit: Press **SET**+  or wait 15s without pressing a key.



NOTE1: if there aren't any parameter in L1, after 3s the "nP" message is displayed. Keep the keys pushed till the L2 message is displayed.

NOTE2: the set value is stored even when the procedure is exited by waiting the time-out to expire.



HOW TO MOVE A PARAMETER FROM THE HIDDEN MENU TO THE FIRST LEVEL AND VICEVERSA.

Each parameter present in the HIDDEN MENU can be removed or put into "THE FIRST LEVEL" (user level) by pressing **SET**+ . In HIDDEN MENU when a parameter is present in First Level the decimal point is on.

TO LOCK THE KEYBOARD

- Keep pressed for more than 3s the  and  keys.
- The "OF" message will be displayed and the keyboard will be locked. If a key is pressed more than 3s the "OF" message will be displayed.

TO UNLOCK THE KEYBOARD

Keep pressed together for more than 3s the  and  keys till the "on" message will be displayed.

8. PARAMETERS

REGULATION

- Hy Differential:** (0.1°C ÷ 25°C / 1°F ÷ 45°F) Intervention differential for set point. Compressor Cut IN is SET POINT + differential (Hy). Compressor Cut OUT is when the temperature reaches the set point.
- LS Minimum SET POINT:** (-55°C+SET/-67°F+SET): Sets the minimum value for the set point..
- US Maximum SET POINT:** (SET+99°C/ SET+99°F). Set the maximum value for set point.
- ot First probe calibration:** (-9.9÷9.9°C / -17°F ÷ 17°F) allows to adjust possible offset of the first probe.
- P2 Evaporator probe presence:** n= not present; y= the defrost stops by temperature.
- oE Second probe calibration:** (-9.9÷9.9°C / -17°F ÷ 17°F) allows to adjust possible offset of the second probe.
- od Outputs activation delay at start up:** (0÷99min) This function is enabled at the initial start up of the instrument and inhibits any output activation for the period of time set in the parameter.
- AC Anti-short cycle delay:** (0÷50 min) minimum interval between the compressor stop and the following restart.
- Cy Compressor ON time with faulty probe:** (0÷99 min) time during which the compressor is active in case of faulty thermostat probe. With Cy=0 compressor is always OFF.
- Cn Compressor OFF time with faulty probe:** (0÷99 min) time during which the compressor is OFF in case of faulty thermostat probe. With Cn=0 compressor is always active.

DISPLAY

- CF Measurement unit:** (°C÷°F) °C = Celsius; °F = Fahrenheit. **WARNING:** When the measurement unit is changed the SET point and the values of the parameters Hy, LS, US, oE, o1, AU, AL have to be checked and modified if necessary.
- rE Resolution (only for °C):**(dE ÷ in) dE= decimal between -9.9 and 9.9°C; in= integer
- Ld Default display:** (P1 ÷ P2) P1= thermostat probe; P2= evaporator probe. SP=Set point (only XR04CX)
- dy Display delay:** (0÷15 min.) when the temperature increases, the display is updated of 1 °C/1°F after this time.

DEFROST

- td Defrost type:** (EL – in) EL= electrical heater, compressor OFF; in= hot gas, compressor ON;
- dE Defrost termination temperature:** (-55÷50°C / -67÷99°F) if P2=Y it sets the temperature measured by the evaporator probe, which causes the end of defrost.
- id Interval between defrost cycles:** (0÷99 minutes) Determines the time interval between the beginning of two defrost cycles.
- Md Maximum length for defrost:** (0÷99 min. with 0 no defrost) when P2=n, (not evaporator probe: timed defrost) it sets the defrost duration, when P2 = y (defrost end based on temperature) it sets the maximum length for defrost.
- dd Start defrost delay:** (0÷99min) This is useful when different defrost start times are necessary to avoid overloading the plant.
- dF Display during defrost:** (rt / it / SP / dF) rt= real temperature; it= start defrost temperature; SP= SET-POINT; dF= label dF.
- dt Drip time:** (0÷99 min) time interval between reaching defrost termination temperature and the restoring of the control's normal operation. This time allows the evaporator to eliminate water drops that might have formed due to defrost.
- dP Defrost at power –on:** (y÷n) y= at power on defrost starts; n= defrost doesn't start at power-on

FANS

- FC Fans operating mode:** (cn, on, cY, oY) cn= in runs with the compressor, OFF during defrost; on= continuous mode, OFF during defrost; cY= runs with the compressor, ON during defrost; oY= continuous mode, ON during defrost.
- Fd Fans delay after defrost:** (0÷99 min) Interval between end of defrost and evaporator fans start.
- FS Fans stop temperature:** (-55÷50°C / -67°F ÷ 99°F) setting of temperature, detected by evaporator probe, above which fans are always OFF.

ALARMS

- AU Maximum temperature alarm:** (AL+99°C/99°F) when this temperature is reached the alarm is enabled, after the "Ad" delay time.
- AL Minimum temperature alarm:** (-55÷AU°C /-67÷AU°F) when this temperature is reached the alarm is enabled, after the "Ad" delay time.
- Ad Temperature alarm delay:** (0÷99 min) time interval between the detection of an alarm condition and alarm signalling.
- dA Exclusion of temperature alarm at startup:** (0÷99 min) time interval between the detection of the temperature alarm condition after instrument power on and alarm signalling.

DIGITAL INPUT

- iP Digital input polarity:** (oP ÷ cL) oP= activated by closing the contact; cL= activated by opening the contact;
- iF Digital input configuration:** (EA/bA/do/dF/Au/Hc) EA= external alarm: "EA" message is displayed; bA= serious alarm "CA" message is displayed; do= door switch function; dF= defrost activation; Au =not used; Hc= inversion of the kind of action;
- di Digital input delay:** (0÷99 min) with iF=EA or bA delay between the detection of the external alarm condition and its signalling. . With iF=do it represents the delay to activate the door open alarm.
- dC Compressor and fan status when open door:** (no/Fn/cP/Fc): no= normal; Fn = Fans OFF; cP =Compressor OFF; Fc = Compressor and fans OFF;
- rd Regulation with door open:** (n÷y) n = no regulation if door is opened; Y= when di is elapsed regulation restarts even if door open alarm is present;

OTHER

- d1 Thermostat probe display (read only)**
- d2 Evaporator probe display (read only)**
- Pt Parameter code table**
- rL Software release**

9. DIGITAL INPUTS (ONLY XR03CX)

The free voltage digital input is programmable in different configurations by the "i1F" parameter.

DOOR SWITCH (iF=do)

It signals the door status and the corresponding relay output status through the "dC" parameter: no = normal (any change); Fn = Fan OFF; CP = Compressor OFF; FC = Compressor and fan OFF. Since the door is opened, after the delay time set through parameter "di", the door alarm is enabled, the display shows the message "dA" and the regulation restarts if rd = y. The alarm stops as soon as the external digital input is disabled again. With the door open, the high and low temperature alarms are disabled.

EXTERNAL ALARM (iF=EA)

As soon as the digital input is activated the unit will wait for "di" time delay before signalling the "EA" alarm message. The outputs status don't change. The alarm stops just after the digital input is deactivated.

SERIOUS ALARM (iF=bA)

When the digital input is activated, the unit will wait for "di" delay before signalling the "CA" alarm message. The relay outputs are switched OFF. The alarm will stop as soon as the digital input is deactivated.

START DEFROST (iF=dF)

It starts a defrost if there are the right conditions. After the defrost is finished, the normal regulation will restart only if the digital input is disabled otherwise the instrument will wait until the "Md" safety time is expired.

INVERSION OF THE KIND OF ACTION: HEATING - COOLING (iF=Hc)

This function allows to invert the regulation of the controller: from cooling to heating and viceversa.

10. INSTALLATION AND MOUNTING

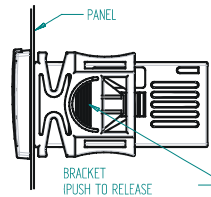

Instrument XR06CX shall be mounted on vertical panel, in a 29x71 mm hole, and fixed using the special bracket supplied. The temperature range allowed for correct operation is 0÷60 °C. Avoid places subject to strong vibrations, corrosive gases, excessive dirt or humidity. The same recommendations apply to probes. Let air circulate by the cooling holes.

11. ELECTRICAL CONNECTIONS

The instrument is provided with screw terminal block to connect cables with a cross section up to 2,5 mm². Before connecting cables make sure the power supply complies with the instrument's requirements. Separate the probe cables from the power supply cables, from the outputs and the power connections. Do not exceed the maximum current allowed on each relay, in case of heavier loads use a suitable external relay.

11.1 PROBES

The probes shall be mounted with the bulb upwards to prevent damages due to casual liquid infiltration. It is recommended to place the thermostat probe away from air streams to correctly measure the average room temperature. Place the defrost termination probe among the evaporator fins in the coldest place, where most ice is formed, far from heaters or from the warmest place during defrost, to prevent premature defrost termination.

12. HOW TO USE THE HOT KEY

12.1 HOW TO PROGRAM THE HOT KEY FROM THE INSTRUMENT (UPLOAD)

1. Program one controller with the front keypad.
2. When the controller is ON, insert the "Hot key" and push Δ key; the "uP" message appears followed a by flashing "Ed"
3. Push "SET" key and the "Ed" will stop flashing.
4. Turn OFF the instrument remove the "Hot Key", then turn it ON again.

NOTE: the "Er" message is displayed for failed programming. In this case push again o key if you want to restart the upload again or remove the "Hot key" to abort the operation.

12.2 HOW TO PROGRAM AN INSTRUMENT USING HOT KEY (DOWNLOAD)

1. Turn OFF the instrument.
2. Insert a programmed "Hot Key" into the 5 PIN receptacle and then turn the Controller ON.
3. Automatically the parameter list of the "Hot Key" is downloaded into the Controller memory, the "do" message is blinking followed a by flashing "Ed".
4. After 10 seconds the instrument will restart working with the new parameters.
5. Remove the "Hot Key"..

NOTE: the "Er" message is displayed for failed programming. In this case push again o key if you want to restart the upload again or remove the "Hot key" to abort the operation.

13. ALARM SIGNALLING

Mess.	Cause	Outputs
"P1"	Room probe failure	Compressor output according to "Cy" e "Cn"
"P2"	Evaporator probe failure	Defrost end is timed
"HA"	Maximum temperature alarm	Outputs unchanged
"LA"	Minimum temperature alarm	Outputs unchanged
"EA"	External alarm	Outputs unchanged
"CA"	Serious external alarm	All outputs OFF
"dA"	Door Open	Compressor and fans restarts

13.1 ALARM RECOVERY

Probe alarms "P1" and "P2" start some seconds after the fault in the related probe; they automatically stop some seconds after the probe restarts normal operation. Check connections before replacing the probe. Temperature alarms "HA" and "LA" automatically stop as soon as the temperature returns to normal values.

Alarms "EA" and "CA" (with iF=bL) recover as soon as the digital input is disabled.

14. TECHNICAL DATA

Housing: self extinguishing ABS.

Case: frontal 32x74 mm; depth 60mm;

Operating Manual

Mounting: panel mounting in a 71x29mm panel cut-out
Protection: IP20; **Frontal protection:** IP65
Connections: Screw terminal block $\leq 2,5 \text{ mm}^2$ wiring.
Power supply: according to the model 230Vac $\pm 10\%$, 50/60Hz --- 110Vac $\pm 10\%$, 50/60Hz
Power absorption: 3.5VA max
Display: 2 digits, red LED, 14,2 mm high; **Inputs:** Up to 2 NTC.
Digital input: free voltage contact
Relay outputs: compressor SPST 8(3) A, 250Vac; SPST 16(6)A 250Vac or 20(8)A 250Vac
 defrost: SPDT 8(3) A, 250Vac
 fan: SPST 8(3) A, 250Vac or SPST 5(2) A
Data storing: on the non-volatile memory (EEPROM).
Kind of action: 1B; **Pollution grade:** 2; **Software class:** A.;
Rated impulsive voltage: 2500V; **Overvoltage Category:** II
Operating temperature: 0+60 °C; **Storage temperature:** -25+60 °C.
Relative humidity: 20+85% (no condensing)
Measuring and regulation range: NTC -40+110°C;
Resolution: 0,1 °C or 1°C or 1 °F (selectable); **Accuracy (ambient temp. 25°C):** $\pm 0,1 \text{ }^\circ\text{C} \pm 1 \text{ digit}$

15. CONNECTIONS

15.1 XR06CX – 20+8+5A OR 16+8+5A – 110VAC OR 230VAC

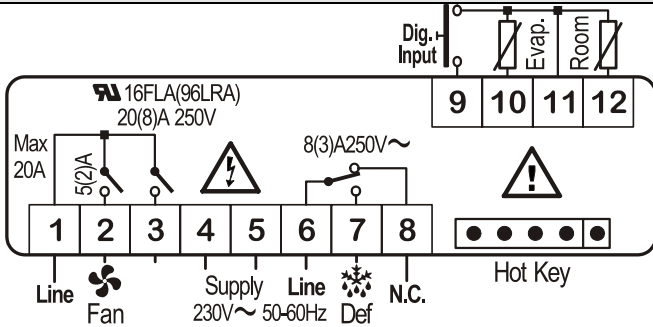

NOTE: The compressor relay is 20(8)A or 16(6)A depending on the model.
NOTE: Connect the 120Vac power supply to 4-5

15.2 XR06CX -- 8+8+8A -- 110VAC OR 230VAC

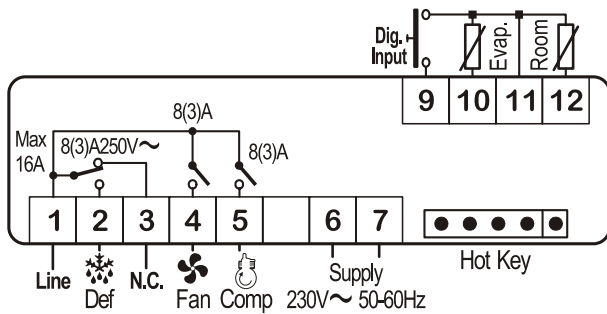

NOTE: Connect the 120Vac power supply to 6-7

16. DEFAULT SETTING VALUES

LAB EL	DESCRIPTION	RANGE	DEFAULT
REGULATION			
Hy	Differential	0.1 + 25°C/1 + 45°F	2.0°C / 4 °F
LS	Minimum Set Point	-55°C+SET/-67°F+SET	-55°C / -55°F
US	Maximum Set Point	SET+99°C/ SET+99°F	99 °C / 99°F
ot	First probe calibration	-9.9+9.9°C/-17+17°F	0.0
P2	Second probe presence	n - Y	y
oE	Second probe calibration	-9.9+9.9°C/-17+17°F	0.0
od	Outputs activation delay at start up	0 + 99 min	0
AC	Anti-short cycle delay	0 + 50 min	1
Cy	Compressor ON time faulty probe	0 + 99 min	15
Cn	Compressor OFF time faulty probe	0 + 99 min	30
DISPLAY			
CF	Measurement units	°C - °F	°C / °F
rE	Resolution (only for °C)	dE - in	dE
Ld	Default Display	P1 - P2 - SP	P1
dy	Display delay	0 + 15 min	0
DEFROST			
td	Defrost type	EL - in	EL
dE	Defrost termination temperature	-55+50°C/-67+99°F	8.0 °C / 46 °F

id	Interval between defrost cycles	0 + 99 hours	6
Md	Maximum length for defrost	0 + 99 min.	30
dd	Start defrost delay	0 + 99 min.	0
dF	Display during defrost	rt - in - SP - dF	it
dt	Drip time	0 + 99 min	0
dP	Defrost at power-on	y - n	n
FANS			
FC	Fans operating mode	cn - on - cY - oY	on
Fd	Fans delay after defrost	0 + 99 min	10
FS	Fans stop temperature	-55+50°C/-67+99°F	2.0 °C / 36 °F
ALARMS			
AU	Maximum temperature alarm	ALL+99°C / ALL+99°F	99 °C / 99 °F
AL	Minimum temperature alarm	-55°C+ALU/-67°F+ALU	-55 °C / -55 °F
Ad	Temperature alarm delay	0 + 99 min	15
dA	Exclusion of temperature alarm at startup	0 + 99 min	90
DIGITAL INPUT			
iP	Digital input polarity	cL - oP	cL
iF	Digital input configuration	EA - bA - do - dF - Au - Hc	EA
di	Digital input delay	0 + 99 min	5
dC	Compressor and fan status when open door	no /Fn / cP / Fc	FC
rd	Regulation with door open	n - Y	y
OTHER			
d1	Thermostat probe display	Read Only	---
d2	Evaporator probe display	Read Only	---
Pt	Parameter code table	Read Only	---
rL	Firmware release	Read Only	---